

HTU21P(F) RH/T Sensor IC – Miniature Relative Humidity and Temperature

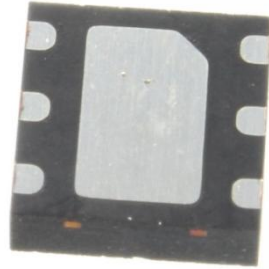
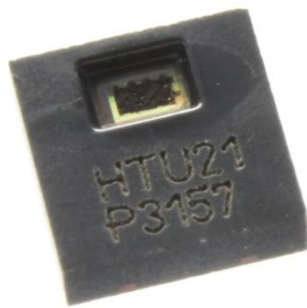

- DFN type package
- Relative Humidity and Temperature Analog Output, PWM interface
- Fully calibrated
- Lead free sensor, reflow solderable
- Low power consumption
- Fast response time

DESCRIPTION

HTU21P(F) is a new humidity and temperature sensor by MEAS. Setting new standards in terms of size and intelligence, it is embedded in a reflow solderable Dual Flat No leads (DFN) package of 3 x 3 x 0.9 mm foot print. This sensor provides calibrated, linearized signals in analog pulse width modulated (PWM) format.

HTU21P(F) humidity sensors are dedicated humidity and temperature plug and play transducers for OEM applications where reliable and accurate measurements are needed. These low power sensors are designed for high volume and cost sensitive applications with tight space constraints.

PWM signal runs on a base frequency of 120Hz, the data signal is provided on SDA line. Pulling SCL high or low allows for switching between humidity and temperature, respectively. The sensor measures twice per second. The PWM signal may be converted to an analog ratiometric interface by adding a low pass filter.

With MEAS' improvements and miniaturization of the sensor, the performance-to-price ratio has been improved – and eventually, any device should benefit from the cutting edge energy saving operation mode. HTU21 is also available with digital I²C (HTU21D(F)).

Optional PTFE filter/membrane (F) protects HTU21P analog humidity sensors against dust and water immersion, as well as against contamination by particles. PTFE filter/membrane preserves a high response time. The white PTFE filter/membrane is directly stuck on the sensor housing.

FEATURES

- Full interchangeability with no calibration required in standard conditions
- Instantaneous desaturation after long periods in saturation phase
- Compatible with automatized assembly processes, including Pb free and reflow processes
- Individual marking for compliance to stringent traceability requirements

APPLICATIONS

- Automotive: defogging, HVAC
- Home Appliance
- Medical
- Printers
- Humidifier

HTU21P(F) RH/T Sensor IC – Miniature Relative Humidity and Temperature

NOMENCLATURE

HTU2XY(F)

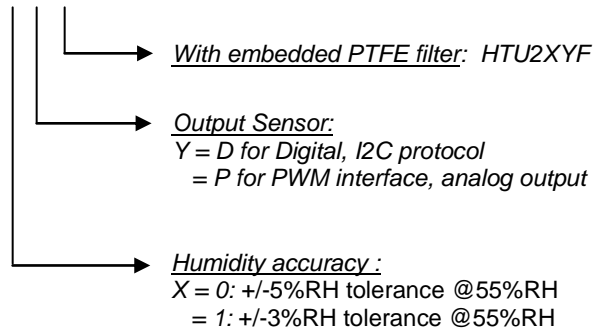

HTU2XY Modules



HTU2XYF Modules

PERFORMANCE SPECS

MAXIMUM RATINGS

| Ratings | Symbol | Value | Unit |
|------------------------------------|-----------|-----------------|----------|
| Storage Temperature | T_{stg} | -40 to 125 | °C |
| Supply Voltage (Peak) | V_{cc} | 3.8V | V_{dc} |
| Humidity Operating Range | RH | 0 to 100 | %RH |
| Temperature Operating Range | T_a | -40 to +125 | °C |
| VDD to GND | | -0.3 to 3.6 | V_{dc} |
| Digital I/O pins (DATA/SCK) to VDD | | -0.3 to VDD+0.3 | V_{dc} |
| Input current on any pin | | -10 to +10 | mA |

Peak conditions: less than 10% of the operating time

Exposure to absolute maximum rating conditions for extended periods may affect the sensor reliability.

HTU21P(F) RH/T Sensor IC – Miniature Relative Humidity and Temperature

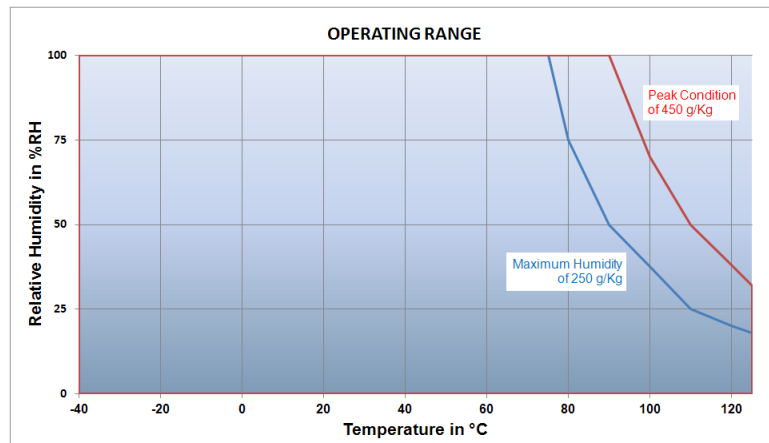

ELECTRICAL AND GENERAL ITEMS

(@T = 25°C, @Vdd = 3V)

| Characteristics | Symbol | Min | Typ | Max | Unit |
|------------------------------------|------------------------------|-------|-----|-------|-----------------|
| Voltage Supply | VDD | 1.5 | 3.0 | 3.6 | V _{dc} |
| Current consumption | idd | | 5 | 14 | μA |
| Power Dissipation | | | 15 | 50 | μW |
| Communication | Analog output, PWM interface | | | | |
| PWM Frequency ⁽¹⁾ | | 108 | 120 | 132 | Hz |
| Temperature drift of PWM frequency | | -0.07 | | -0.12 | Hz/°C |
| Measurement Frequency | | | 2 | | Hz |
| Switch RH/T on DATA | SCK high → RH, SCK low → T | | | | |
| Storage | -40°C/125°C | | | | |

(1) Conditions: Temp=40°C

HTU21P(F) RH/T Sensor IC – Miniature Relative Humidity and Temperature

SENSOR PERFORMANCE

RELATIVE HUMIDITY

(@T = 25°C, @Vdd = 3V)

| Characteristics | | Symbol | Min | Typ | Max | Unit |
|------------------------------------------------------|-----------------------|-----------------|-----|-------------|-------|--------|
| Resolution | 10 bit | | | 0.04 | | %RH |
| Humidity Operating Range | | RH | 0 | | 100 | %RH |
| Relative Humidity Accuracy @25°C (10%RH to 95%RH) | typ | | | ±2 | | %RH |
| | max | | | See graph 1 | | %RH |
| Replacement | fully interchangeable | | | | | |
| Temperature coefficient (from 0°C to 80°C) | | T _{cc} | | | -0.15 | %RH/°C |
| Humidity Hysteresis | | | | ±1 | | %RH |
| Recovery time after 150 hours of condensation | | t | | 10 | | s |
| Long term drift | | | | 0.5 | | %RH/yr |
| Response Time (at 63% of signal) from 33% to 75%RH | | T _{RH} | | 5 | 10 | s |

⁽¹⁾ Typical values are recommended for calculating energy consumption while maximum values shall be applied for calculating waiting times in communication.

⁽²⁾ At 1m/s air flow

GRAPH 1 : RELATIVE HUMIDITY ERROR BUDGET CONDITIONS AT 25°C

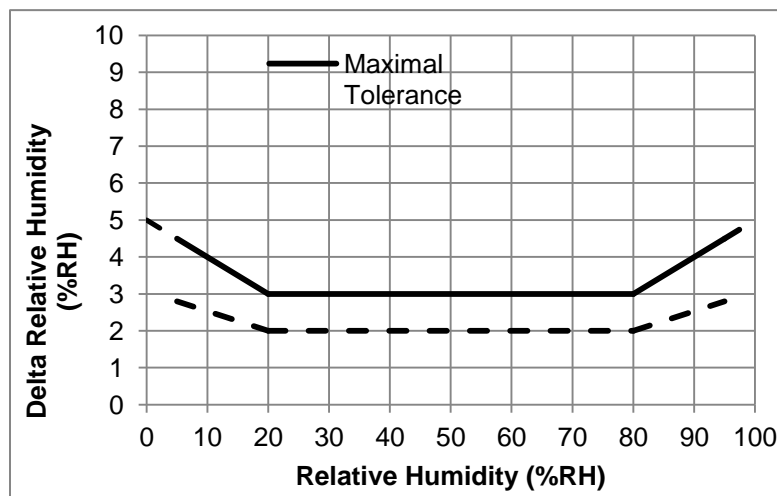

- HTU21P(F) sensors are specified for optimum accuracy measurements within 5 to 95%RH.
- Operation out of this range (< 5% or > 95% RH, including condensation) is however possible.

TEMPERATURE COEFFICIENT COMPENSATION EQUATION

Using the following temperature coefficient compensation equation will guarantee Relative Humidity accuracy given p.3, from 0°C to 80°C:

HTU21P(F) RH/T Sensor IC – Miniature Relative Humidity and Temperature

$$RH_{compensateT} = RH_{actualT} + (25 - T_{actual}) \times CoeffTemp$$

$RH_{actualT}$ Ambient humidity in %RH, computed from HTU21P(F) sensor
 T_{actual} Humidity cell temperature in °C, computed from HTU21P(F) sensor
 $CoeffTemp$ Temperature coefficient of the HTU21P(F) in %RH/°C

TEMPERATURE

| Characteristics | | Symbol | Min | Typ | Max | Unit |
|-------------------------------------------------------------------|--------|--------|-----------------------|-------------|------|-------|
| Resolution | 12 bit | | | 0.01 | | °C |
| Temperature Operating Range | | T | -40 | | +125 | °C |
| Temperature Accuracy @25°C | typ | | | ±0.3 | | °C |
| | max | | | See graph 2 | | °C |
| Replacement | | | fully interchangeable | | | |
| Long term drift | | | | 0.04 | | °C/yr |
| Response Time (at 63% of signal) from 15°C to 45°C ⁽²⁾ | | T_T | | 10 | | s |

⁽¹⁾ Typical values are recommended for calculating energy consumption while maximum values shall be applied for calculating waiting times in communication.

⁽²⁾ At 1m/s air flow

GRAPH2 : TEMPERATURE ERROR BUDGET

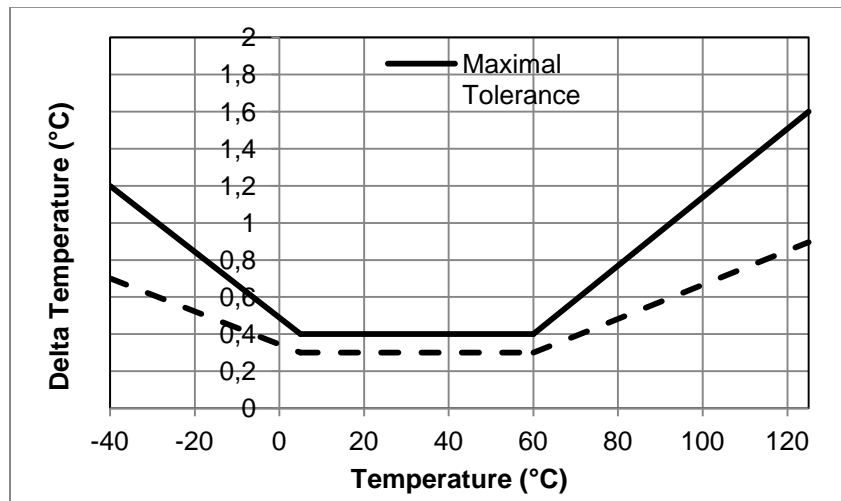

USER GUIDE HTU21P(F)

APPLICATION INFORMATION

- **Soldering instructions: Lead free reflow soldering recommended process**

For soldering HTU21P(F) sensor standard reflow soldering ovens may be used.

HTU21P(F) RH/T Sensor IC – Miniature Relative Humidity and Temperature

HTU21P(F) sensor as a humidity sensitive component (as classified by IPC/JEDEC J-STD-020 or equivalent documented procedure with peak temperature at 260°C during up to 30 seconds for Pb-free assembly in IR/convection reflow ovens) must be handled in a manner consistent with IPC/JEDEC J-STD-033 or an equivalent documented procedure. IPC-1601 provides humidity control, handling and packing of PCBs.

The HTU21P(F) sensor is qualified to withstand one lead free reflow soldering recommended process profile below according to JEDEC standard.

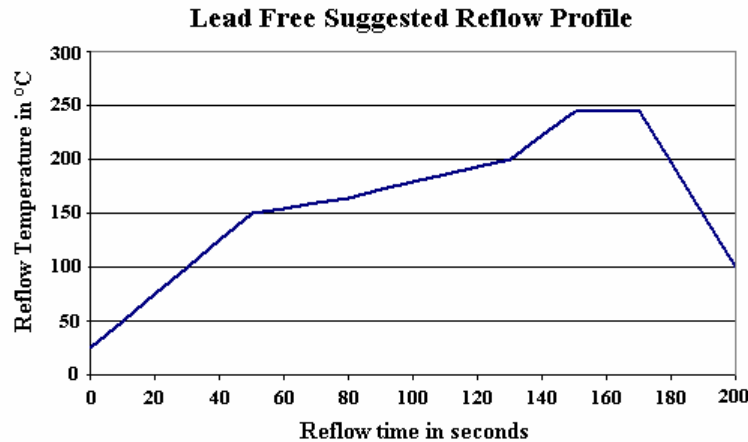

Mount parts within 24 hours after printing solder paste to avoid potential dry up.

For manual soldering, contact time must be limited to 5 seconds at up to 350°C.

For the design of the HTU21P(F) sensor footprint, it is recommended to use dimensions according to figure below.

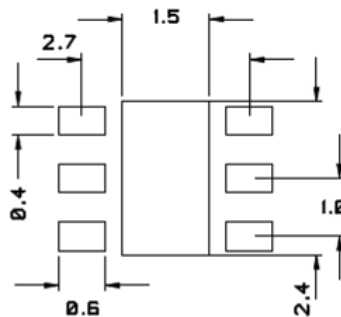

Recommended footprint for HTU21P(F) sensors. Values in mm.

No specific conditioning of devices is necessary after soldering process, either manual or reflow soldering. Optimized performance, in case of metrological measurements, can be reached with stabilization of devices (24 hours at 25°C/55%RH). Similar process is advised after exposure of the devices to extreme relative humidity conditions.

- **Storage Conditions and Handling Instructions**

It is recommended to store HTU21P(F) sensor in its original packaging at following conditions: Temperature shall be in the range of -40°C – 125°C.

HTU21P(F) RH/T Sensor IC – Miniature Relative Humidity and Temperature

- **Temperature effects**

Relative humidity reading strongly depends on temperature. Therefore, it is essential to keep humidity sensors at the same temperature as the air of which the relative humidity is to be measured.

In case of testing or qualification the reference sensor and test sensor must show equal temperature to allow for comparing humidity readings.

The HTU21P(F) sensor should be mounted in a way that prevents heat transfer from electronic sensor or that keeps it as low as possible. Advice can be ventilation, reduction of copper layers between the HTU21P(F) sensor and the rest of the PCB or milling a slit into the PCB around the sensor (1mm minimum width).

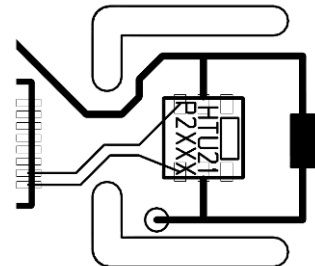

Example of HTU21P(F) sensor mounting with slits mills to minimize heat transfer

- **Materials Used for Sealing / Mounting**

For sealing and gluing (use sparingly), use high filled epoxy for electronic packaging and silicone. For any specific material please request to sales@sensorway.cn

- **Wiring Considerations and Signal Integrity**

Power supply pins (VDD, GND) must be decoupled with a 100nF capacitor. Capacitor should be placed as close as possible to the sensor.

- **ESD (Electrostatic Discharge)**

ESD immunity is qualified according to:

- JEDEC JESD22-A114 method (Human Body Model at ±4kV) for pads & open window
- JEDEC JESD22-A115 method (Machine Model ±200V)
- ESDA ESD-STM5.3.1-1999 and AEC-Q100-011 (charged device model, 750V corner pins, 500V other pins)

Latch-up immunity is provided at a force current of ±100mA with Tamb=25°C according to JEDEC JESD78. For exposure beyond named limits the sensor need additional protection circuit.

INTERFACE SPECIFICATION

| N° | Function | Comment |
|-----|----------|--------------------------|
| 1 | DATA | Data bit-stream |
| 2 | GND | Ground |
| 3 | NC | Must be left unconnected |
| 4 | NC | Must be left unconnected |
| 5 | VDD | Supply Voltage |
| 6 | SCK | Selector for RH or T |
| PAD | | Ground or unconnected |



**HTU21
P3157**

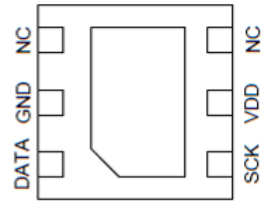

HTU21P(F) RH/T Sensor IC – Miniature Relative Humidity and Temperature

- **Power Pins (VDD, GND)**

The supply voltage of HTU21P(F) sensors must be in the range of 1.5VDC - 3.6VDC. Recommended supply voltage is 3VDC (regulated).

However the typical application circuit includes a 100nF decoupling capacitor between VDD and GND, placed as close as possible to the sensor.

- **Output Selector Pad (SCK)**

SCK is used to select relative humidity or temperature output. SCK high yields humidity output, SCK low yields temperature. Please note that a change of SCK will affect the output on DATA after maximum 1.2 seconds.

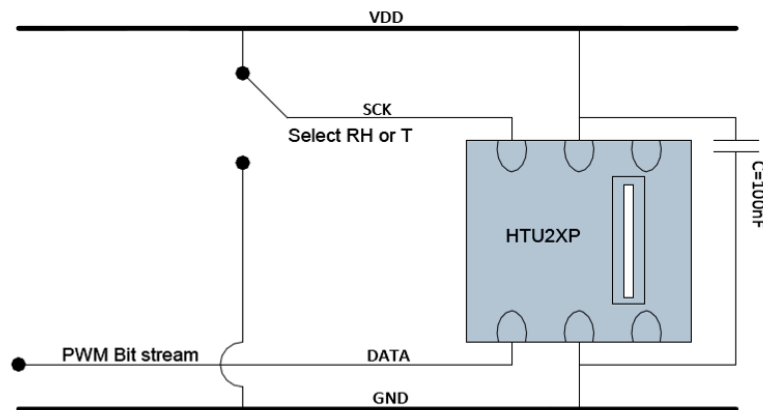

Typical application circuit, including decoupling of VDD and GND by a capacitor.

- **Bit Stream Pad (DATA)**

On DATA line, the HTU21P(F) sensor is providing PWM output. The signal is carrying relative humidity or temperature data depending on SCK being high or low, respectively. See Table next page for detailed I/O characteristic of the HTU21P(F) sensor.

ELECTRICAL CHARACTERISTICS

- **Input/output characteristics**

(VDD=1.5V to 3.6V, Temperature=-40°C to 125°C unless otherwise noted)

| Characteristics | Symbol | Min | Typ | Max | Unit |
|---------------------|--------|--------|-----|--------|------|
| Output Low Voltage | VOL | 0 | | 30%VDD | V |
| Output High Voltage | VOH | 70%VDD | | VDD | V |
| Output Sink Current | IOL | | | 40 | μA |

COMMUNICATION WITH HTU21P(F) SENSOR

- **Start-up sensor**

HTU21P(F) RH/T Sensor IC – Miniature Relative Humidity and Temperature

As a first step, the HTU21P(F) sensor is powered up to VDD (between 1.5V and 3.6V). Then the HTU21P(F) sensor starts measuring and providing data on PWM bit-stream.

- **PWM Specification**

Pulse Width Modulation (PWM) runs on a constant frequency and the measured information is provided as duty cycle on that frequency. Such information is measured humidity for SCK pulled high and temperature for SCK pulled low.

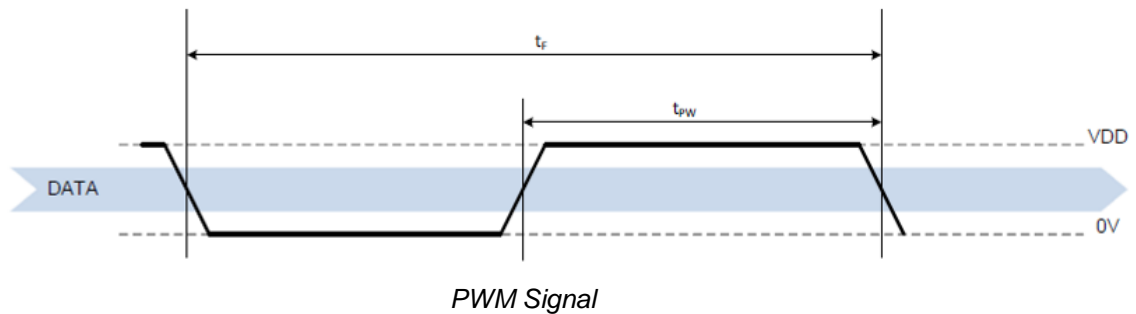

Base frequency runs constantly at approximately 120 Hz, hence t_F is about 8.3ms. The signal is provided on t_{PW} as a ratio of t_F . The measured data – either relative humidity or temperature – is provided as ratio of t_{PW} and t_F . t_{PW} shall always be given as ratio of t_F to make it independent of variations of the base frequency.

CONVERSION OF SIGNAL OUTPUTS

Resolution is set to 10 bit relative humidity and 12 bit temperature reading and cannot be changed. The sensor reading is linear and hence it can be converted to a physical value by an easy linear equation.

To accommodate/adapt any process variation (nominal capacitance value of the humidity die), tolerances of the sensor above 100%RH and below 0%RH must be considered. As a consequence:

- RH output can reach 118%RH and above this value, there will have a clamp of the RH output to this value.
- RH output can reach -6%RH and below this value, there will have a clamp of the RH output to this value.

- **Relative Humidity conversion**

With the relative humidity signal output S_{RH} , the relative humidity is obtained using the following formula (result in %RH), no matter which resolution is chosen:

$$RH = -6 + 125x \frac{t_{PW}}{t_F}$$

- **Temperature conversion**

The temperature T is calculated by inserting the ratio of t_{PW} ad t_F into the following formula (result in °C), no matter which resolution is chosen:

$$Temp = -46.85 + 175.72x \frac{t_{PW}}{t_F}$$

HTU21P(F) RH/T Sensor IC – Miniature Relative Humidity and Temperature

APPLICATION: DEW POINT TEMPERATURE MEASUREMENT

The **dew point** is the temperature at which the water vapor in the air becomes saturated and condensation begins.

The dew point is associated with relative humidity. A high relative humidity indicates that the dew point is closer to the current air temperature. Relative humidity of 100% indicates that the dew point is equal to the current temperature (and the air is maximally saturated with water). When the dew point stays constant and temperature increases, relative humidity will decrease.

Dew point temperature of the air is calculated using Ambient Relative Humidity and Temperature measurements from HTU21P(F) sensor with following formulas given below:

Partial Pressure ($PP_{T_{amb}}$) formula from Ambient Temperature:

$$PP_{T_{amb}} = 10^{\left[A - \frac{B}{(T_{amb} + C)} \right]}$$

Dew point Temperature (T_d) formula from Partial Pressure ($PP_{T_{amb}}$):

$$T_d = - \left[\frac{B}{\log_{10} \left(RH_{amb} \times \frac{PP_{T_{amb}}}{100} \right) - A} + C \right]$$

| | |
|----------------|-----------------------------------------------------------------|
| $PP_{T_{amb}}$ | Partial Pressure in mmHg at ambient temperature (T_{amb}) |
| RH_{amb} | Ambient humidity in %RH, computed from HTU21P(F) sensor |
| T_{amb} | Humidity cell temperature in °C, computed from HTU21P(F) sensor |
| T_d | Calculated Dew Point in °C |
| A, B, C | Constants: A=8.1332; B=1762.39; C=235.66 |

PACKAGE OUTLINE

- HTU21P Sensor Dimensions

HTU21P(F) RH/T Sensor IC – Miniature Relative Humidity and Temperature

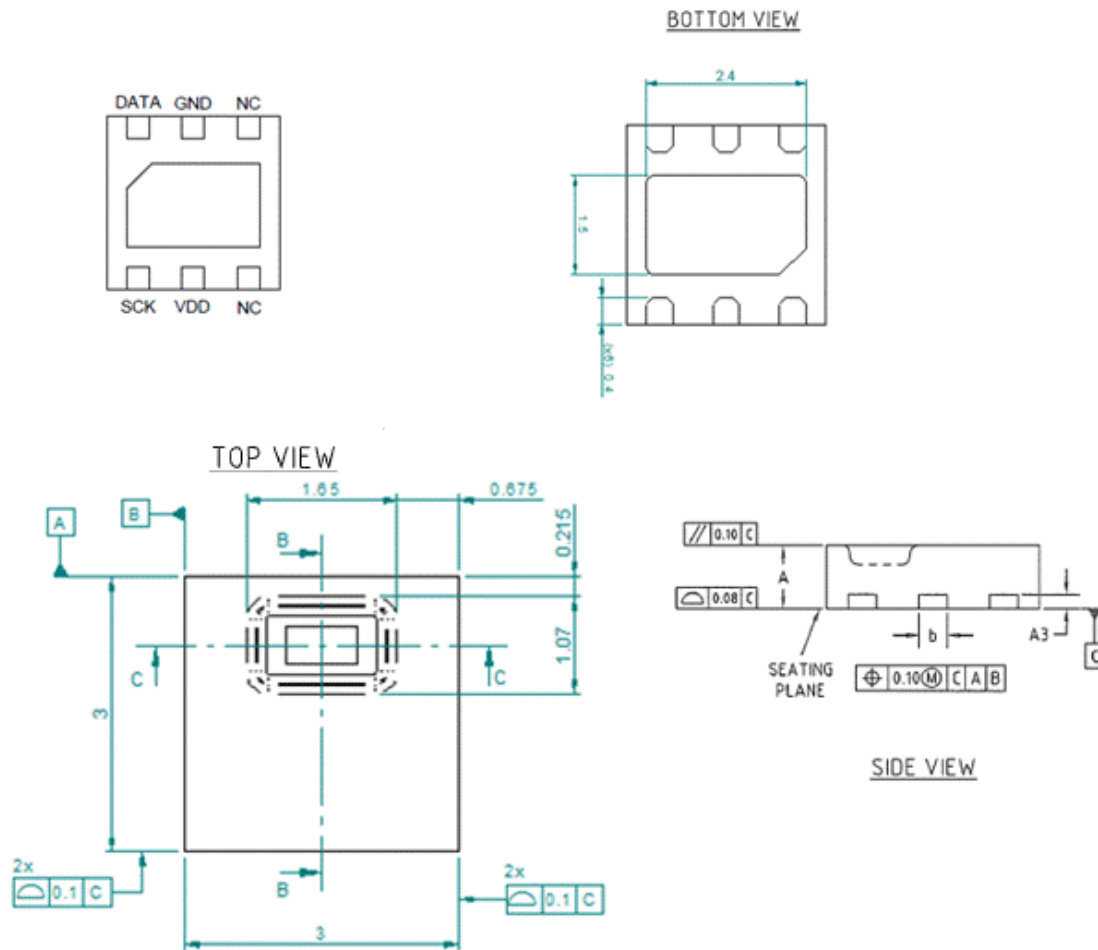

HTU21P(F) RH/T Sensor IC – Miniature Relative Humidity and Temperature

- HTU21PF Sensor Dimensions

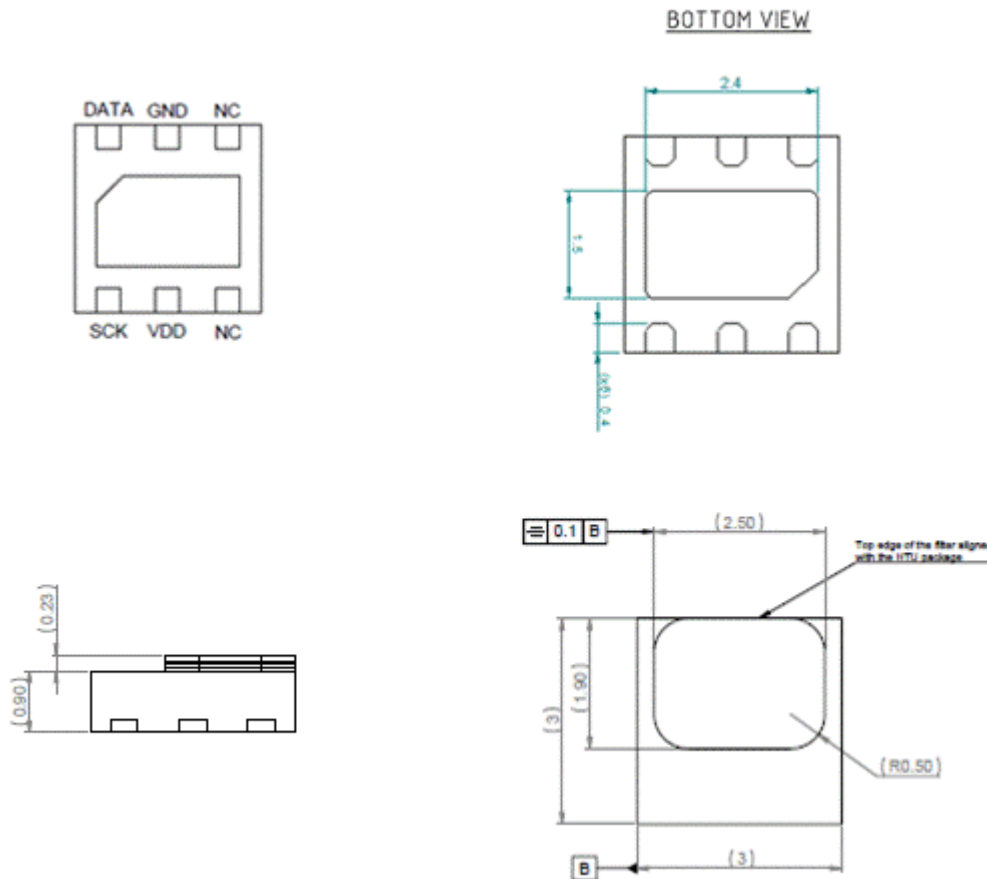

Dimensions are given in mm, tolerances are ± 0.1 mm. The die pad (thermal center pad) is internally connected to GND.

- Packaging Type**

HTU21P(F) sensors are provided in DFN packaging. DFN stands for Dual Flat No leads.

The HTU21P(F) sensor chip is mounted to a lead frame made of Cu and plated with Ni/Pd/Au. Chip and lead frame are over molded by green epoxy-based mold compound. Please note that side walls of sensors are diced and hence lead frame at diced edge is not covered with respective protective coating.

The total weight of the sensor is 0.025g.

- Traceability Information**

All HTU21P(F) sensors are laser marked with an alphanumeric, five-digit code on the sensor as pictured below.

The marking on the HTU21P(F) sensor consists of two lines with five digits each:

HTU21P(F) RH/T Sensor IC – Miniature Relative Humidity and Temperature

- The first line denotes the sensor type: HTU21.
- The second line denotes several information as:
 - The first digit of the second line defines the output mode:
 - D = digital and I²C
 - P = PWM
 - The second digit defines the manufacturing year: 2 = 2012, 3 = 2013, etc.
 - The last three digits represent an alphanumeric tracking code. That code can be decoded by MEAS only and allows for tracking on batch level through production, calibration and testing and will be provided upon justified request.

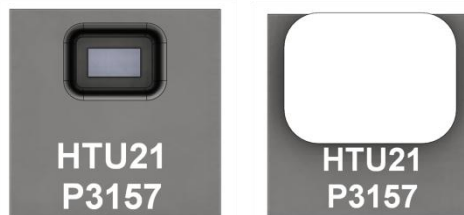

Laser marking on HTU21P(F) sensor

Reels are also labeled, as displayed below and give additional traceability information.

Made in France



measurement
SPECIALTIES™

HPPxxxxxxx - IC 2X Humidity & Temperature

Lot No. : 2XY(F)-TTTTTTTTT



Quantity: QQQQ 

Datecode: YYDDD



With:

XX: Sensor Type (21 for HTU21P(F))
 O: Output mode (D = Digital, P = PWM)
 (F): Sensor with PTFE membrane (only for HTU21PF)
 NN: Product revision number
 TTTTTTTTT: MEAS Traceability Code
 YY: Two last digits of the year
 DDD: Day of the year
 QQQQ: Quantity per reel (400, 1500 or 5000 units)

- **Shipping Package**

HTU21P(F) sensors are shipped in tape & reel packaging, sealed into antistatic ESD bags. Standard packaging sizes are 400, 1500 and 5000 units per reel. Each reel contains 440mm (55 pockets) header tape and 200mm

HTU21P(F) RH/T Sensor IC – Miniature Relative Humidity and Temperature

(25 pockets) trailer tape. The drawing of the packaging tapes with sensor orientation is shown in the picture below.

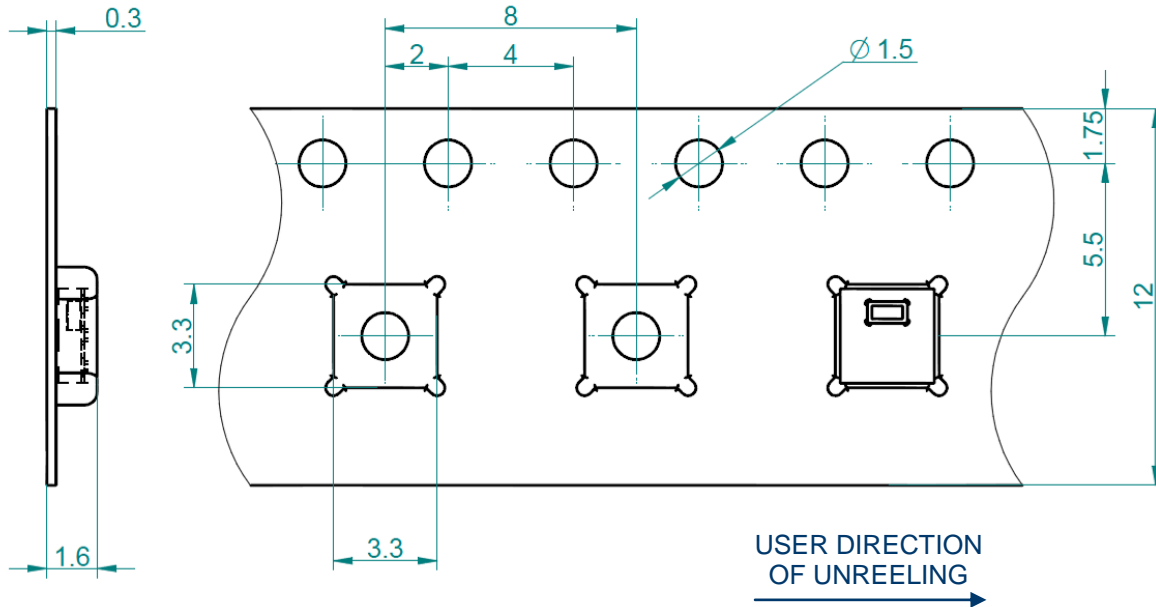

- **Packaging reels**

For 400 and 1500 units: outside diameter of 7" (178mm) and a 1/2" (13mm) diameter arbor hole.

For 5000 units: outside diameter of 13" (330mm) and a 1/2" (13mm) diameter arbor hole.

ORDERING INFORMATION

**** HTU21P – I.C 21P RH/T PWM ****

PACKAGE: TAPE AND REEL M.P.Q OF 400 PIECES, 1500 PIECES OR 5000 PIECES

- HPP845E032R4 - I.C 21P RH/T PWM in tape and reel of 400 pieces
- HPP845E032R1 - I.C 21P RH/T PWM in tape and reel of 1500 pieces
- HPP845E032R5 - I.C 21P RH/T PWM in tape and reel of 5000 pieces

**** HTU21PF – I.C 21PF RH/T PWM WITH PTFE MEMBRANE ****

PACKAGE: TAPE AND REEL M.P.Q OF 400 PIECES, 1500 PIECES OR 5000 PIECES

- HPP845E132R4 - I.C 21PF RH/T PWM in tape and reel of 400 pieces
- HPP845E132R1 - I.C 21PF RH/T PWM in tape and reel of 1500 pieces
- HPP845E132R5 - I.C 21PF RH/T PWM in tape and reel of 5000 pieces

Customer Service contact details

HTU21P(F) RH/T Sensor IC – Miniature Relative Humidity and Temperature

北京赛斯维测控技术有限公司
 北京市朝阳区望京西路48号
 金隅国际D座302
 电话：+ 86 010 8477 5646
 传真：+ 86 010 5894 9029
 邮箱：sales@sensorway.cn
<http://www.sensorway.cn>

| Edition | Comments | Who | Date |
|---------|-----------------------------------------------------------------------------------------|--------------------|--------------|
| 0 | Document Creation | D. LE GALL | July 12 |
| 1 | General update | D. LE GALL-ZIRILLI | August 13 |
| 2 | General update | M.ROBERT | October 13 |
| 3 | Obsolescence of HTU2XS (SDM interface) version Update of external package dimensions | M.ROBERT | January 14 |
| 4 | Part number and designation modification | M.ROBERT | April 14 |
| 5 | Table I/O characteristics completion | M.ROBERT | September 14 |

The information in this sheet has been carefully reviewed and is believed to be accurate; however, no responsibility is assumed for inaccuracies. Furthermore, this information does not convey to the purchaser of such devices any license under the patent rights to the manufacturer. Measurement Specialties, Inc. reserves the right to make changes without further notice to any product herein. Measurement Specialties, Inc. makes no warranty, representation or guarantee regarding the suitability of its product for any particular purpose, nor does Measurement Specialties, Inc. assume any liability arising out of the application or use of any product or circuit and specifically disclaims any and all liability, including without limitation consequential or incidental damages. Typical parameters can and do vary in different applications. All operating parameters must be validated for each customer application by customer's technical experts. Measurement Specialties, Inc. does not convey any license under its patent rights nor the rights of others.